

BreathSpec®



Quickstart Manual



**G.A.S. Gesellschaft für
analytische Sensorsysteme mbH**

BreathSpec® – Quickstart Manual

Version 1.05, April 2026

Valid from BreathSpec® Firmware Version 4.80

All data, texts, designs, images and other elements used in this user manual are protected by copyright law. Any infringement may be subject to legal action.

Passing it on to third parties and producing copies of any kind or form – on the whole or in parts - is not permitted without written agreement of G.A.S. Any infringement may be subject to legal action.

G.A.S. reserves the right to realize technical changes to the product without explicitly mentioning them.

BreathSpec® is a registered trademark. Any infringement may be subject to legal actions.

The BreathSpec® does not have a medical approval.

CE-Marking according to:

International Standard EN ISO 17050-1:2004

European Union Low Voltage Directive 2006/95/EC

European Union Electromagnetic Compatibility Directive 2004/108/EC

© Copyright 2026

**G.A.S. Gesellschaft für analytische Sensorsysteme mbH
44227 Dortmund - Germany**

All Rights Reserved.

**G.A.S. Gesellschaft für analytische Sensorsysteme mbH
Otto-Hahn-Str. 15
D-44227 Dortmund
Germany**

**Phone: (+49) 231/9742-6550
Fax.: (+49) 231/9742-6555
E-Mail: support@gas-dortmund.de
Internet: www.gas-dortmund.de**

Table of Content

1	General Information	5
1.1	Information about the Manual.....	5
1.2	Explanation of Symbols	5
1.3	Notation for dialogs, elements and references	6
1.4	Scope of Supply BreathSpec® with Circular Gas Flow Unit (Version 5G1)...	7
1.5	Scope of Supply Special edition BreathSpec with Airsense μ TD Unit (Version 5G2)	12
1.6	Liability and Guarantee.....	16
1.7	Copyright.....	16
1.8	Return and Disposal.....	17
1.9	Software Updates.....	17
1.10	Customer Service	17
2	Safety.....	18
2.1	Intended Use Only.....	18
2.2	Responsibility of Operator	18
2.3	Requirements of Personnel	19
2.4	Dangers.....	19
3	Transport, Packing and Storage	21
3.1	Inspection after Transport.....	21
3.2	Packing.....	21
3.3	Storage and Transport.....	21
4	Cleaning and Maintenance	22
4.1	Cleaning	22
4.2	Maintenance.....	22
5	Installation BreathSpec® Device (Version 5G1) with Circular Gas Flow Unit (CGFU).....	24
5.1	Installation Requirements	24
5.2	Installing the device	25
5.3	Mounting the Mouthpiece holder	29
5.4	Connecting the Mouthpiece tube	30
5.5	Prepare the device for operation	34
6	Installation BreathSpec® Device (Version 5G2) with Airsense μ TD	38
6.1	Installation Requirements	38

BreathSpec® – Quickstart Manual

6.2	Installing the device	39
6.3	Prepare the device for operation	45
7	System Operation	49
7.1	Measurement Requiements	49
7.2	Measurement Program.....	49
7.3	Workflow: Breath Sampling via Handheld Breath Sampler.....	50
7.3.1	Workflow: Installation of Disposable Reservoir Tube and Mouthpiece..	50
7.3.2	Workflow: Execute a breath measurement using the Handheld	51
7.4	Workflow: Breath Sampling via Disposable Breath Sampler	54
7.4.1	Start a breath measurement using disposable breath sampler	54
7.5	Workflow: Exemplary Breath sampling with a sample bag	57
7.6	Workflow: Measurement in ID Input Mode.....	59
8	Appendix	61
8.1.1	IMS-Spectrum Examples	61
8.2	Corresponding G.A.S. Documents and Tutorials.....	63

1 General Information

1.1 Information about the Manual



INFORMATION!

This **Quickstart User Manual** is an excerpt of the most important information for installation and initial setup from the User Manual. It is an **addition to the User Manual** and does not replace the User Manual.

This manual describes a safe and adequate handling of the device. Following the instructions of the indicated safety aspects and instructions as well as the national and/or local rules and general safety regulations concerning the prevention of accidents are absolutely imperative.

Before starting the work with the device read the manual completely and thoroughly particularly the chapter security and respective safety references. Assure that you/the operator comprehend the terms described.

The manual is part of the device. It must be stored together with and next to the device at any time.



INFORMATION!

The graphics in this user manual are schematic and may differ from the actual conditions. The firmware and PC software screenshots in this user manual may differ from the actual conditions.

1.2 Explanation of Symbols

Important and safety-relevant references in this manual are characterized by symbols. These indications which are in-line with industrial safety must be respected and followed at any time.



INFORMATION

This symbol calls information, which are to be considered for efficient and perfect handling of the equipment.



WARNING

This symbol indicates references, which can lead to damages, malfunctioning and/or loss of the device.



DANGER

This symbol marks references, which can lead to health impairments, injuries, lasting body damages or to death due to electric current.



DANGER

This Symbol marks paragraphs, which describe potential dangers and damage due to exposure to radioactive radiation.



DANGER

This symbol marks references, which describe working procedures that demand special attention to avoid spreading of biohazard



WARNING

This symbol marks references, which can lead to health impairments, injuries due to pinching.



DANGER

This symbol marks paragraphs, which describe situations in which surface parts of the device can heat up to a point where touching it or bringing objects close to it may be hazardous.

1.3 Notation for dialogs, elements and references

Example Dialog:

System > **Connections** > **LAN File Transfer** > **Settings...** > **Test Connection**

Example Elements:

Gas Out, **Sample gas In**

Example: References

Advanced User Manual, **Chapter 5.1 Installation Requirements**

Example: Information

keep the transport box

1.4 Scope of Supply BreathSpec® with Circular Gas Flow Unit (Version 5G1)

Assure that you have received the full scope of supply. If there is any part missing, please contact the GAS-hotline immediately.

Standard Scope of Supply



BreathSpec® Device (1 piece)
including connected Circular Gas Flow Unit (CGFU) (1 piece)



Power supply with power plug (1 piece)



Mouthpiece Handheld holder arm with
screws

BreathSpec® – Quickstart Manual



Mouthpiece Handheld with heatable Transferline (1 piece)



BreathSpec® Gas tube Kit (installed)

- Driftgas/Carriergas Adapter (1 piece)
- 0,6 m 3 mm PFA Tubes with 3 mm Swagelok-Connector (2 pieces)



CGFU Connection cable (installed)
(1 piece)



LAN Cable (1 piece)



Disposable Breath Reservoir Kit

- Mouthpieces (100 pieces)
- Reservoir tube (100 pieces)



Inner Syringe Body (2 ml syringe) (50 pieces)



Sampling Syringe (5 ml syringe) (100 pieces)



BreathSpec® Blind plug Set (5 pieces)

(Swagelok 3 mm Blind plug with red cap installed on device connectors)

BreathSpec® – Quickstart Manual



Torx Tool Kit

- Torx Srewdriver 8 mm (1 piece)
- Torx Srewdriver 10 mm (1 piece)
- Torx Srewdriver 30 mm (1 piece)



Document Map with Documents and Device User Manuals (1 piece)



USB-Stick Box with Software und Documents (1 piece)



Custom Ketones Standard (1piece)

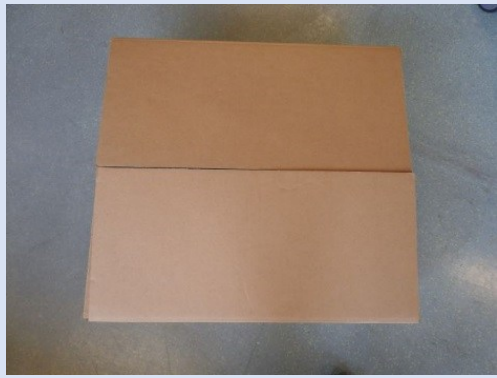

Transport box (1 piece)



Transport palett (60 x 80 cm)

Optional Scope of Supply (only available if ordered)



Laptop Computer (different design) including software for control and evaluation



CGFU-Filter Set

(2x Moisture-Trap, 1x Hydrocarbon-Trap)

1.5 Scope of Supply Special edition BreathSpec with Airsense μ TD Unit (Version 5G2)

Assure that you have received the full scope of supply. If there is any part missing, please contact the GAS-hotline immediately.

Standard Scope of Supply



BreathSpec® Device (1 piece)



μ TD with accessories in transport case (1 piece)



Power supply with power plug (1 piece)



BreathSpec® Gas tube Kit

Driftgas/Carriergas/ μ TD Adapter (1 piece)

- 2 m 3 mm PFA Tubes with 3 mm Swagelok-Connector (4 pieces)



Molecular sieve trap (200 ml)
(1 piece)



LAN Cable (1 piece)



BreathSpec® Blind plug Set (7 pieces)

(Swagelok 3 mm Blind plug with red cap installed on device connectors)

BreathSpec® – Quickstart Manual



Torx Tool Kit

- Torx Srewdriver 8 mm (1 piece)
- Torx Srewdriver 10 mm (1 piece)



Document Map with Documents and Device User Manuals (1 piece)



USB-Stick Box with Software und Documents (1 piece)



Custom Ketones Standard (1piece)

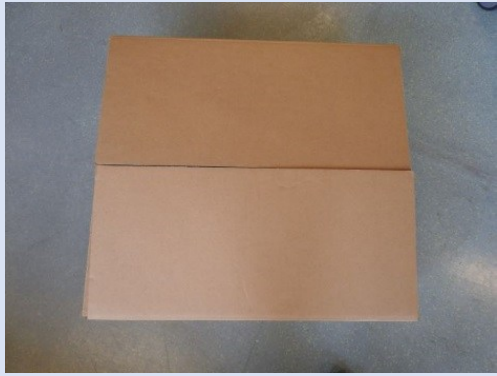

Transport box (1 piece)



Transport palett (60 x 80 cm)

Optional Scope of Supply (only available if ordered)

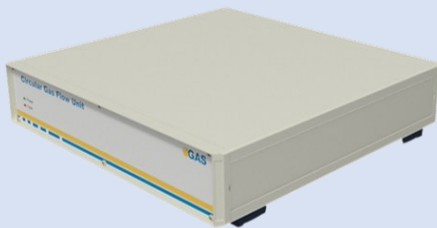

Circular Gas Flow Unit with accessories



Nitrogen Generator with accessories
(example picture)

BreathSpec® – Quickstart Manual



Laptop Computer (different design) including software for control and evaluation



Sampling Syringe 5 ml syringe for Luer Adapter) (100 pieces)

1.6 Liability and Guarantee

This user manual describes the safe and proper handling of the device.

All data and reference within this manual are compiled under the valid regulations, the state-of-the-art as well as G.A.S. experiences of several years.

This user manual must be stored together with and close to the device at any time and accessible to all persons, who operate or handle the device at any time.

This user manual must be read carefully before starting to work with the device. G.A.S. does not assume any liability for damage and disturbances, resulting from disregard of the instructions contained in this user manual. All claims of any kind related to damage from a not intended use of the device will be rejected.

G.A.S. reserves the right to realize technical changes of the product due to improvements without explicitly mentioning them.

1.7 Copyright

The manual is confidential. It is beyond doubt exclusively made and also meant for the personnel directly dealing with the equipment. All data, texts, designs, pictures

and other representations within this manual are protected in the sense of the copyright law and are subject to further commercial patent rights. Each abusive is punishable by law.

Passing it on to third persons as well as duplications in any kind and form - also in part - as well as the use and/or report of contents are not permitted without written agreement of the manufacturer. Offences lead to payment of damages. We reserve ourselves all rights of the practice of commercial patent rights.

1.8 Return and Disposal

For an adequate disposal, the device or/and its equipment must be returned to the G.A.S. or to a third party authorized by the G.A.S.! For questions please contact G.A.S.

1.9 Software Updates

If there are any software updates customers will be contacted by G.A.S. Gesellschaft für analytische Sensorsysteme mbH as soon as the updates are available. The updates are free of charge within the first 12 months after delivery. Users will be provided with information about the changes and instructions for executing the updates.

1.10 Customer Service

For questions concerning G.A.S. products a customer service is available:

G.A.S. Gesellschaft für analytische Sensorsysteme mbH
Otto-Hahn-Straße 15
44227 Dortmund
Germany
Phone: +49 (0) 231 / 97 42 - 65 50
Fax: +49 (0) 231 / 97 42 - 65 55
support@gas-dortmund.de

The telephone hotline is available from monday to friday from 9:00 to 16:00 hours. In urgent cases or if you use fax or email please provide a telephone number for callbacks.

2 Safety

2.1 Intended Use Only



WARNING!

Usage other than described in this manual may damage the device and/or harm persons involved.

Do not use the device for other purposes. Damages due to misuse are not covered by the guarantee. Such damage claims will be rejected.

The device and its equipment are not certified for the employment in areas with explosive gas air mixtures.

All claims or requirements of any kind against the manufacturer and/or its authorized persons that arise due to damages from a not intended use of the device will be rejected. All damages that arise from a not intended use are of the operator's responsibility.

The intended use of the equipment and its correct handling according are described in the operating instructions of this manual. Other parts than the parts belonging to the scope of supply, may only be used after G.A.S. approval.

2.2 Responsibility of Operator

The device may only be operated in a perfect technical condition. Before putting the device into operation, the condition of the device and its equipment must be checked. The information and instructions provided in this manual must be followed at any time.

Besides the instructions provided in this manual the local rules for the prevention of accidents, general safety regulations - valid for the area of application of the device - as well as the valid environmental-protection regulations must be considered and respected.

The responsible technicians and operators must make sure a failure-free use of the device. Responsibilities among the involved persons regarding installation, operation, maintenance, and cleaning must be made clear.

The device can be used to analyze human breath. A hygienic operation must be ensured at all times. Ensure that human breath analysis does not conflict with local

ethical compliance. The breath analysis data might imply private information covered by data privacy protection that has to be obeyed.

2.3 Requirements of Personnel

Only authorized and trained technical personnel may work with the instruments. The operator must have received an instruction over existing and all possible dangers and should be regularly instructed in safety procedures and environmental protection and that the personnel is fully aware of the complete operating instructions and particularly the safety notes. Personnel that might be under the influence of drugs or alcohol are to be kept off the device at any time.

Technical personnel in this context are defined as skilled employees who are knowledgeable due to their educational background. In case the foreseen personnel do not have the necessary qualifications to operate the instrument, it must be trained. Further to that non-authorized personnel should not operate the device.

The competencies for the work on and with the device must be specified and kept undoubtedly at any time so that with respect to security issues no unclear situation might come up.

Any changes of the equipment, which impair security of the personnel, must immediately be reported to the operator and every person dealing with it.

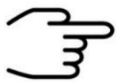

INFORMATION!

- Operators must be aware of local hygienic standards.
- Operators must be aware of local ethical compliances regarding human breath analysis.
- Operators must be aware of local privacy protection compliances.

2.4 Dangers

The device and its equipment is subject to an endangerment analysis. The construction and execution of the device corresponds to the today's state-of-the-art. The device is reliable in service when operated according to its intended use.



INFORMATION!

If the housing of the device is damaged, the device must not be used anymore and must be returned to the G.A.S. by using the original transportation case.



DANGER

The BreathSpec® device contains a radioactive radiation Tritium source which in all EURATOM countries is below the exemption limit of 1 GBq for tritium acc. to Table B (column 2) of Article 26, of the Directive 2013/59 EURATOM of December 5th, 2013.

However, do not open the device! Do not try to recover malfunctions of the device! Malfunction recovery, repairs and any maintenance work may only be performed by G.A.S. or by qualified personnel authorized by G.A.S.



DANGER

The BreathSpec® and its equipment is not certified for the employment in areas with explosive gas air mixtures (Zone 0).



DANGER

Exercise great care in handling current-carrying parts like the power supply cord. Do not get directly in touch with current-carrying parts. Do not open the housing. Do not use damaged parts.



DANGER

All parts of the equipment that are in contact with human breath must either be disposed of or sanitized to prevent biohazard



DANGER

When Nitrogen is used as drift gas and helium as carrier gas, ignition of a helium plasma may occur due to the high voltage present in conjunction with a radiation source. This can damage the IMS.

**DANGER**

This symbol marks paragraphs, which describe situations in which surface parts of the device can heat up to a point where touching it or bringing objects close to it may be hazardous.

3 Transport, Packing and Storage

3.1 Inspection after Transport

Check the supply immediately after delivery concerning its completeness and/or transport damages. If you detect externally visible transport damage, do not receive the supply, or only under reservation. State the extent of the damage on the provided delivery note and/or the transportation documents of the feeder. Generate a complaint. Lodge a complaint of covered defect immediately after recognizing, as claims due to transport damages can only be made valid within the complaint periods (usually 7 days).

3.2 Packing

If no return agreement regarding the packing was agreed upon dispose the packaging material always in an environmentally friendly way and according to valid local regulations. If necessary, ask a recycling company.

**INFORMATION!**

It is recommended to **keep the transport box** for a safety return transport.

3.3 Storage and Transport

Store the device only under the following conditions:

- **When not in use store the equipment in the supplied casing**
- **Prevent unauthorized access**
- **Do not store outside**
- **Protect the equipment from moisture and dust**
- **Put protective caps on all gas sockets**
- **Avoid mechanical vibrations**

- Do not expose the equipment to aggressive substances
- Protect the equipment from direct sun light
- Storage temperature: 5 to 40 °C
- Relative Air Humidity: 0- 90% RH, prevent condensing
- Instrument's position: Horizontal

The equipment should be moved only within the provided carrying case. By this means, transport damages can be avoided. The above-mentioned values are considered for an instrument transported in its original new packing.



WARNING!

Protective caps should be put on gas sockets in case the device is stored or transported.

4 Cleaning and Maintenance

Natural aging and the wear of certain components of the equipment require a regular cleaning and maintenance.

4.1 Cleaning

Clean the device only with a dry or easily damp cloth.



WARNING!

Do not use cleaning agents, which contain solvents, acids or bases.

4.2 Maintenance



INFORMATION!

Maintenance of the device should only be carried out at G.A.S. or through specially trained and by G.A.S. authorized personnel.

The recommended **maintenance interval** for **BreathSpec®** device is **12 months** for **Circular Gas Flow Unit (CGFU)** is **6 months**.



INFORMATION!

Maintenance of the equipment must be carried out by G.A.S. or personnel authorized by G.A.S.

Please contact G.A.S. 6-8 weeks in advance to optimize the turn-around time!

5 Installation BreathSpec® Device (Version 5G1) with Ciruclar Gas Flow Unit (CGFU)

5.1 Installation Requirements

The following requirements must be fulfilled by the customer:

Location of Installation

- Available space of 600 x 700 x 300 mm (W x D x H)
- Ambient temperature of 5 – 40 °C
- Humidity: 0-90% RH, non-condensing

Electricity

- Electricity supply free of interferences
- Power Supply of 230 V \pm 10%, 50- 60 Hz \pm 1%

Safety

- Availability of exhaust system for device exhaust gas tube (Sample Gas out)

Computer

- Computer with current Microsoft Windows operating system
- Administrator right to install G.A.S. software



INFORMATION!

To ensure correct measurements it is necessary to **connect the supplied exhaust tube** (Sample gas out).

The exhaust system must **not generate any negative pressure**.

5.2 Installing the device

1

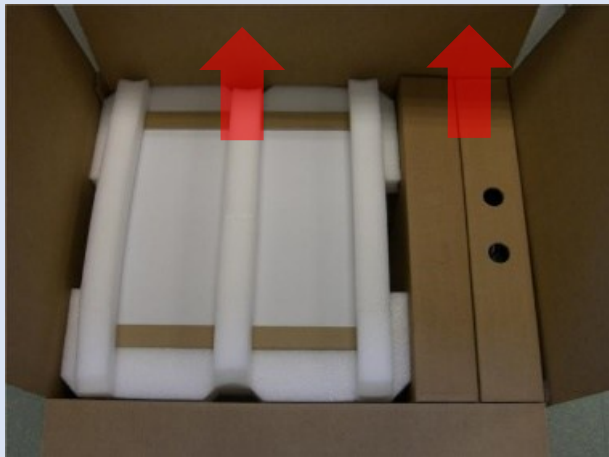

Unpack the device.

Remove the foam spacers.

Remove the accessories boxes.

Lift the device from the transport box.



WARNING!

Do not deploy the device in areas exposed to explosive substances or mixtures!

2

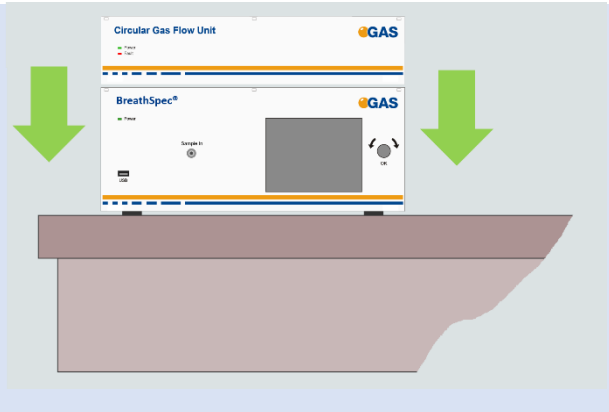

Place it on a robust tabletop of minimum footprint size of 60 cm x 70 cm. Ensure that there is enough working space at the rear side of the device.

3

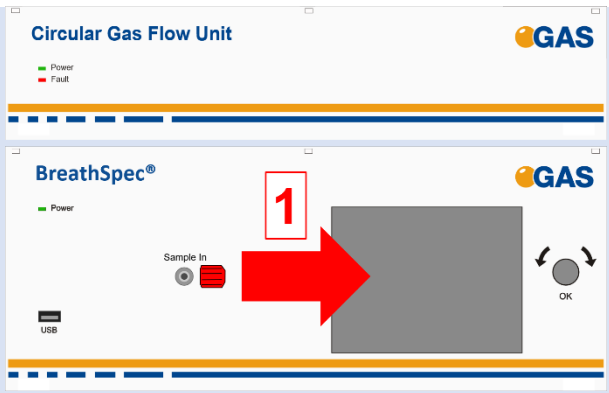

Remove red protective cap from gas sockets at front of housing. Retain for future use.

BreathSpec® – Quickstart Manual

4

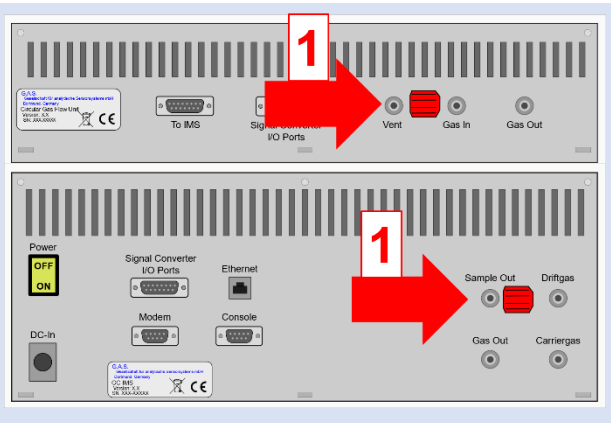

Remove red protective caps from gas socket at rear of housing. Retain for future use.



INFORMATION!
Protective caps should be put on gas sockets in case the device is stored or transported.



WARNING!
It is absolutely necessary to **remove all protective caps before the system is switched on.**



INFORMATION!
Gas tubes and **GCFU Connection Cable** are **preinstalled.**

5

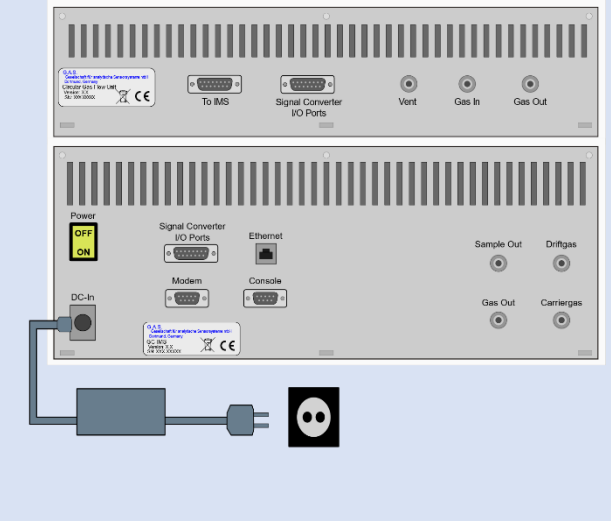

Connect device to power supply.
Connect power supply to power socket.

6

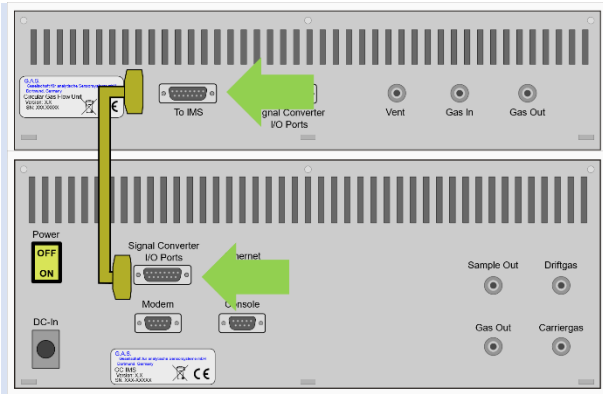

Connect CGFU-Connection-Cable.
(normally pre-installed!)

7

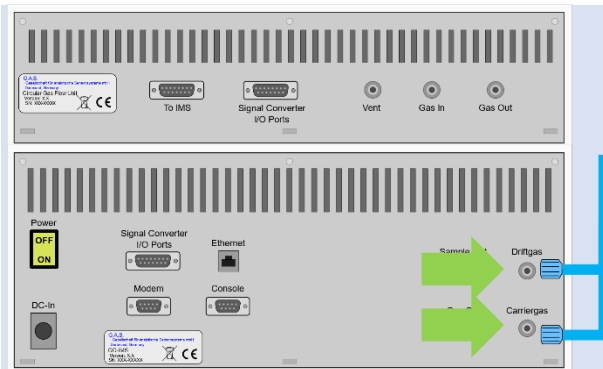

Connect the **Driftgas-/Carriergas-Adapter** to the **Driftgas-** and the **Carriergas-Connector**.
(normally pre-installed!)

8

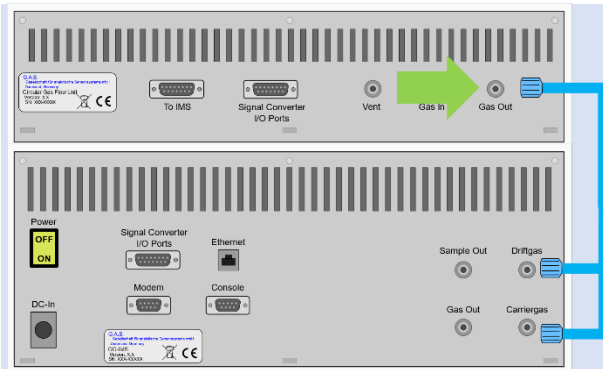

Connect CGFU **Gas Out** outlet to **Driftgas-/Carriergas-Adapter** using a PFA tube.
(normally pre-installed!)

9

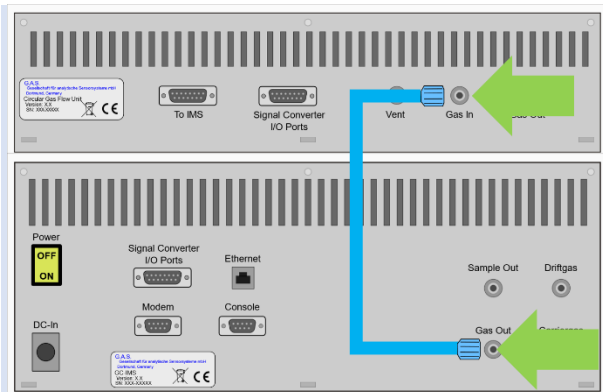

Connect CGFU **Gas In** inlet to GC-IMS **Gas Out** outlet using a PFA tube.
(normally pre-installed!)

10

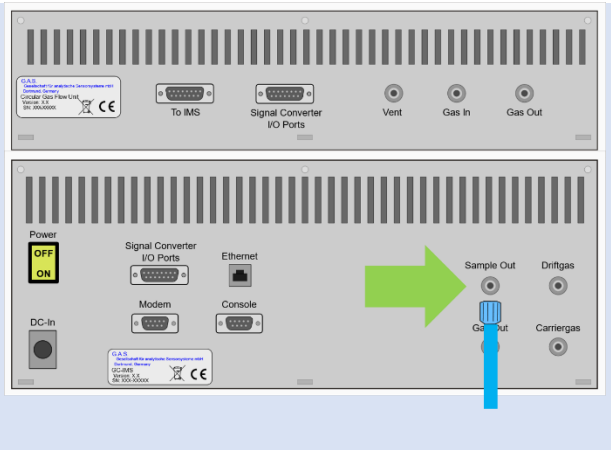

Connect **Sample Out** to an appropriate waste gas ventilation system.

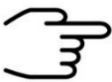

INFORMATION!
To ensure correct measurements it is absolutely necessary to **connect the supplied exhaust tubes** (Gas out and Sample gas out).
The exhaust tubes (Gas out and Sample gas out) **must be led separately into the exhaust system and must not be connected.**
The exhaust system must **not generate any negative pressure.**

11

Connect the Sampling System:

- Mouthpiece tube with heated transferline **see chapter 5.4**
- Heated Luer-Lock-Adapter **see chapter 5.5**

12

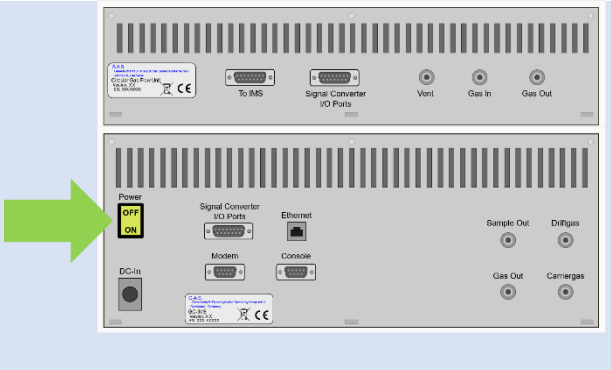

Switch on device.

13 Option

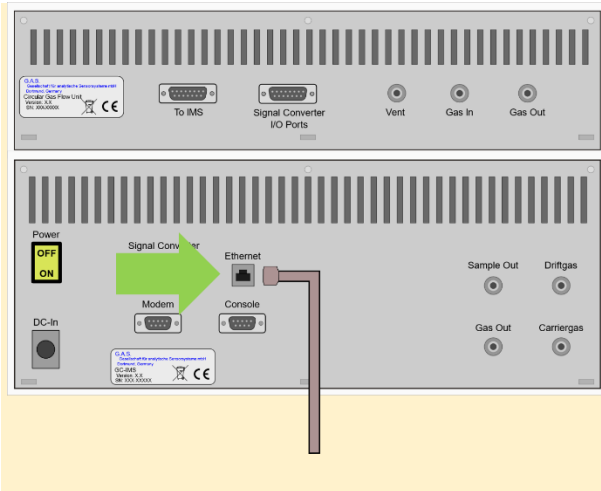

For file transfer via LAN:
Connect the **Ethernet** socket with an appropriate Ethernet cable to a LAN.



INFORMATION!

When using a CGFU unit the total flow (EPC1 and EPC2) is limited to 400 ml/min.

5.3 Mounting the Mouthpiece holder

1



Mouthpiece-Handheld holder arm with screws

2

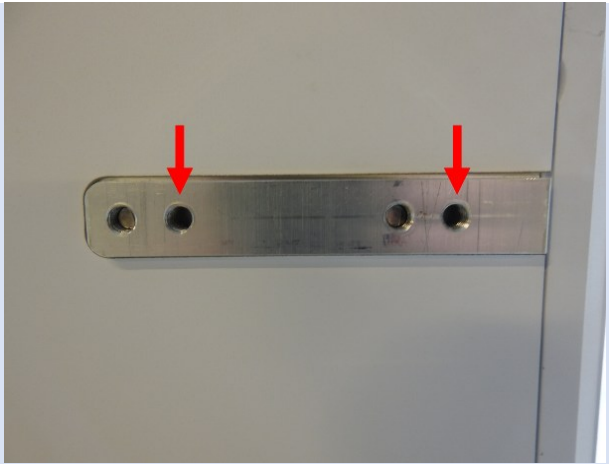

For mounting the arm use the marked holes.

3



Mount the arm with a Torx screwdriver T30.

5.4 Connecting the Mouthpiece tube

1



Mouthpiece Handheld with heatable Transfer-line

2



Pull the screw upwards.

3



Remove the handling screw.

4



Connect the transferline to the sample-in connector.

5



Tighten the screw with a spanner.

6



Connect the current supply cable.

7



Tighten the current supply cable.

8

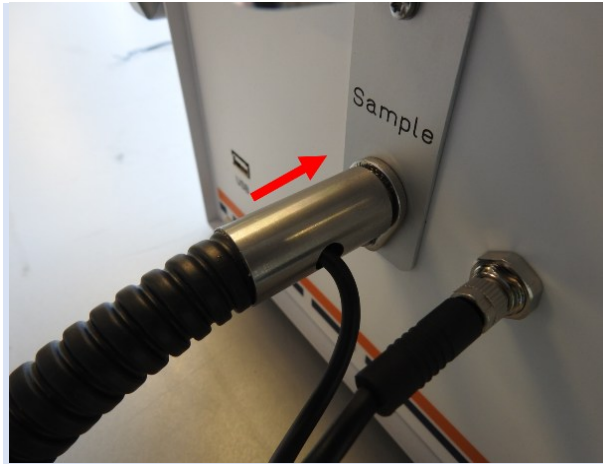

Push the Transfer-line connector onto the **Sample in connector**.

9



Place the Mouthpiece handheld into the handheld holder.

10



Switch on the BreathSpec.

5.5 Prepare the device for operation

Before using the device for the first time or after being disconnected from the nitrogen source for some time it must be cleaned to ensure proper operating conditions. In this case start the **cleaning mode**.

An appropriate cleaning period duration must be chosen depending on how long the device was switched off and on the extent of contamination. It is recommended to clean the device for at least **15 hours** before operating it for the first time. If the Spectrum is not clean repeat the process. A **reference spectrum** for the evaluation can be found in the supplied **Analytical Approval**.



INFORMATION!

After the cleaning process the device needs at least **2 hours** to cool down the internal components to their required temperatures.

The duration of the cool down process is depending on the temperature default settings.



INFORMATION!

If the BreathSpec is turned off, wait a minimum of 10 minutes before restarting as otherwise the CGFU pump will not start due to overpressure within the system.

1

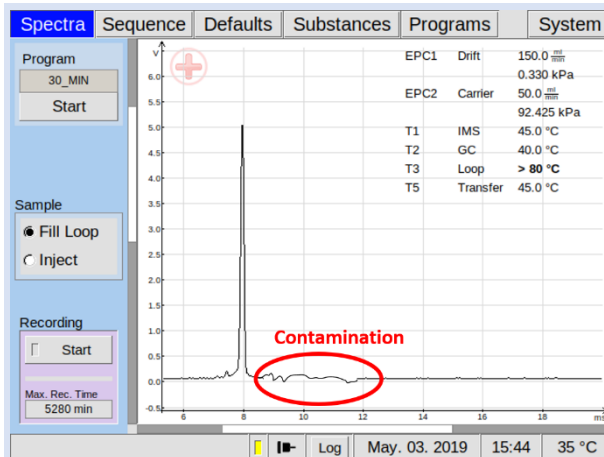

Inspect spectrum for contamination. Control the baseline. Start cleaning when contaminated. Contamination is indicated by peaks or the disappearing of the RIP.

2
Option

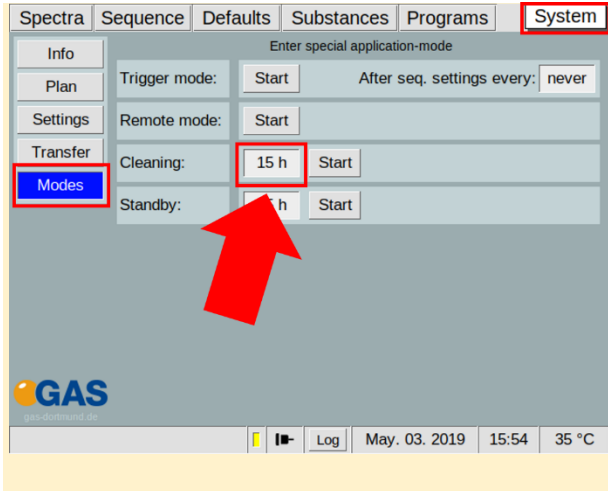

Select duration in hours:

System > **Modes** >

Cleaning Mode > **x h**

3
Option

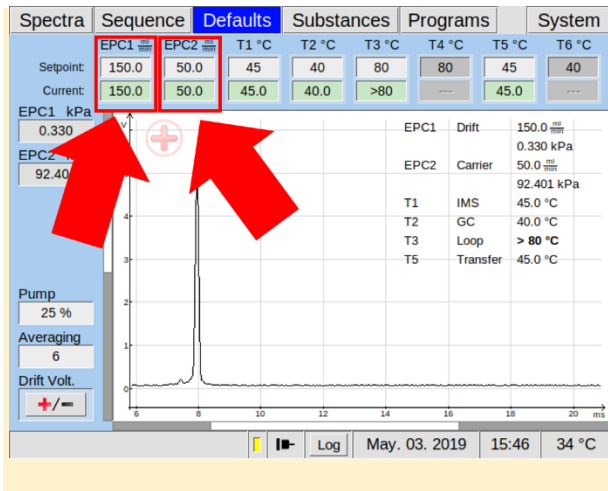

To speed up this process, increase flow rate of EPC1 and EPC2 to their maximum values (e.g 500/150 ml/min):

Defaults > **EPC1** > **EPC2**

4

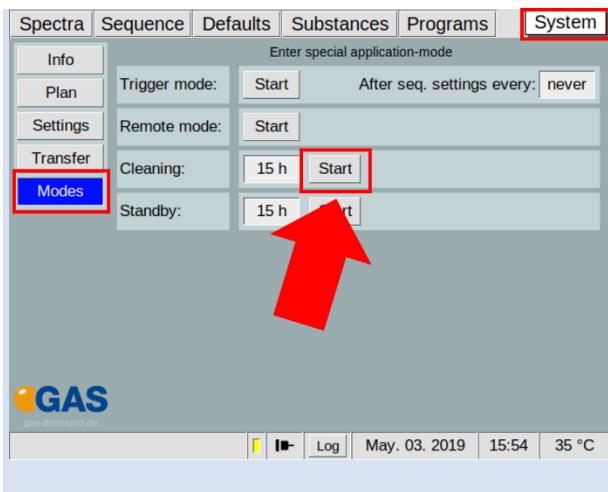

Start cleaning:

System > **Modes** >

Cleaning Mode > **Start**

5

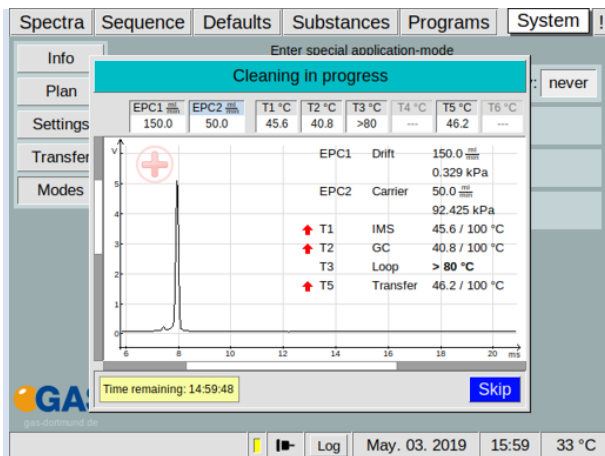

Wait until cleaning process is completed. The process can be stopped with **Skip**.

6

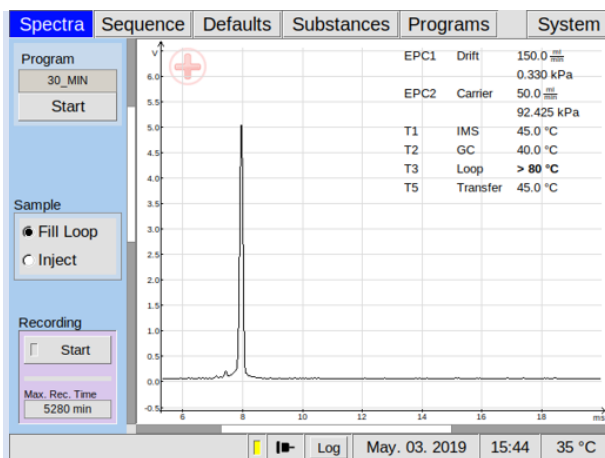

After all temperatures reached the default values inspect visually the current spectrum and compare it with the reference spectrum of the analytical approval. **The RIP should reach ~80% of the RIP height displayed in the delivered Analytical Approval of the device under same measurement conditions of G.A.S. The assessment of the readiness to measure is additionally supported by the system.**

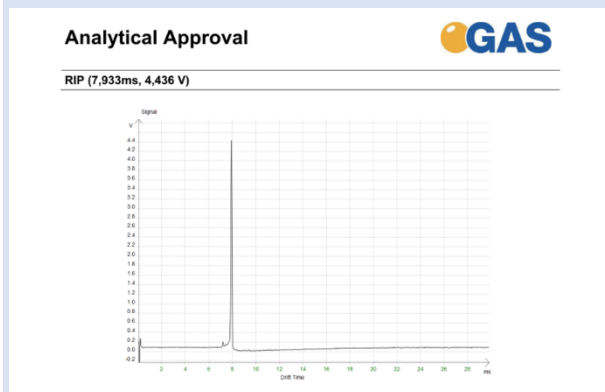

If not check the gas quality and/or install additional purification cartridges and start the cleaning procedure again.



INFORMATION!

The device is delivered with an acceptance snapshot. This snapshot defines the system performance during device acceptance and is used to assess the readiness for measurement. Any deviations from this are displayed in the Error Information Window. **The default values can be adjusted by the customer.**

6 Installation BreathSpec® Device (Version 5G2) with Airsense µTD

6.1 Installation Requirements

The following requirements must be fulfilled by the customer:

Location of Installation

- Available space of 600 x 700 x 300 mm (W x D x H)
- Ambient temperature of 5 – 40°C
- Humidity: 0-90% RH, non-condensing

Electricity

- Electricity supply free of interferences
- Power Supply of 230 V ± 10%, 50- 60 Hz ± 1%

Gas supply

- Nitrogen (Quality 5.0 (99,999%) or Synthetic Air (Quality 5.0 (99,999%))
- Stainless steel pressure reducer adjustable adjustable pressure range of 3 – 6 bar and 3 mm Swagelok connector (recommended 5 bar)

Safety

- Availability of exhaust system for device exhaust gas tubes (Gas out and Sample Gas out)

Computer

- Computer with current Microsoft Windows operating system
- Administrator right to install G.A.S. software



INFORMATION!

To ensure correct measurements it is absolutely necessary to **connect the supplied exhaust tubes** (Gas out and Sample gas out).

The exhaust tubes (Gas out and Sample gas out) **must be led separately into the exhaust system and must not be connected.**

The exhaust system must **not generate any negative pressure.**

6.2 Installing the device

1

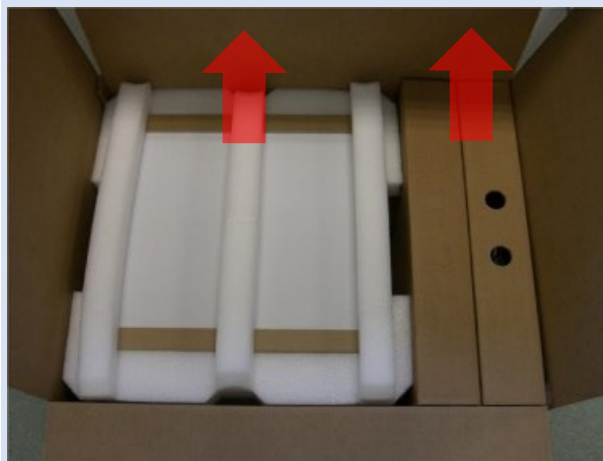

Unpack the device.

Remove the foam spacers.

Remove the accessories boxes.

Lift the device from the transport box.



WARNING!

Do not deploy the device in areas exposed to explosive substances or mixtures!

2

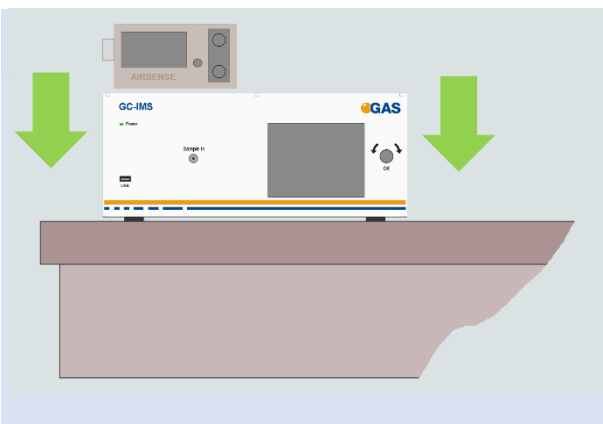

Place it on a robust table top of minimum footprint size of 60 cm x 70 cm. Ensure that there is enough working space at the rear side of the device.

BreathSpec® – Quickstart Manual

3

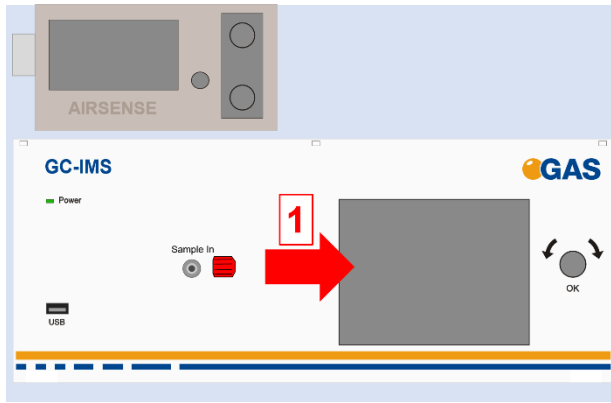

Remove red protective caps from gas sockets at front of housing. Retain for future use.

4

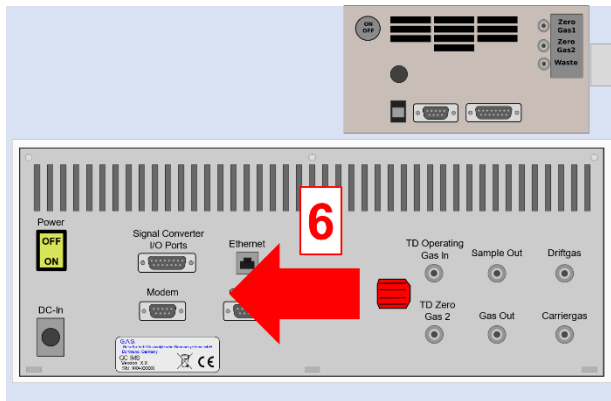

Remove red protective caps from gas socket at rear of housing. Retain for future use.

5

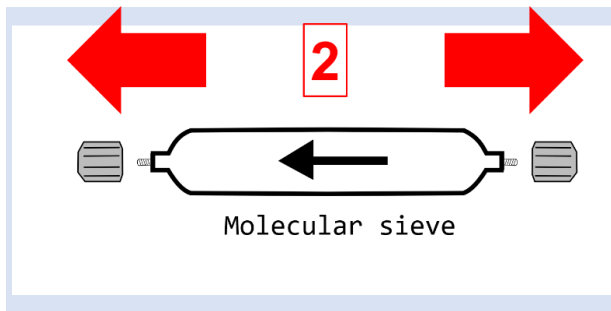

Remove protective caps from molecular sieve. Retain for future use.

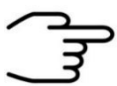

INFORMATION!

Protective caps should be put on gas sockets in case the device is stored or transported.



WARNING!

It is absolutely necessary to **remove all protective caps before the system is switched on.**

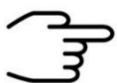

INFORMATION!

Make sure that the power switch is set to OFF before connecting the power supply.

6

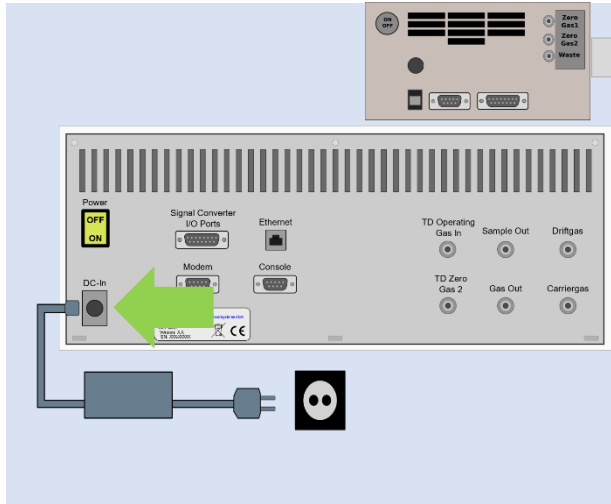

Connect BreathSpec device to power supply.

Connect power supply to power socket.

7

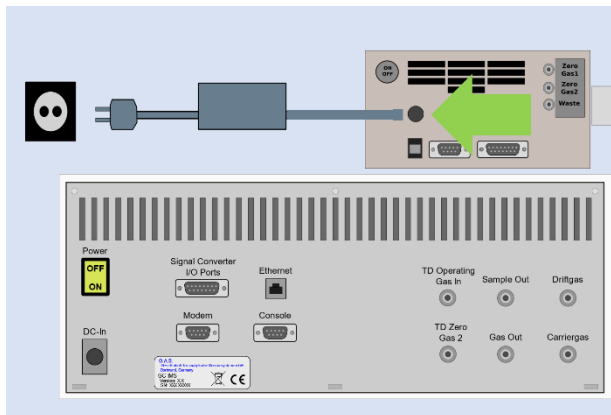

Connect µTD device to power supply.

Connect power supply to power socket.

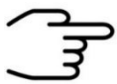

INFORMATION!

Only use **stainless steel pressure reducers**, **PFA tubes** with 3 mm outer diameter and **3 mm Swagelok** connectors.

Screw on the Swagelok caps manually and fix them by screwing a further half-turn using a 12 mm open-end wrench.



WARNING!

Do not introduce aggressive gases or liquids into the device.

8

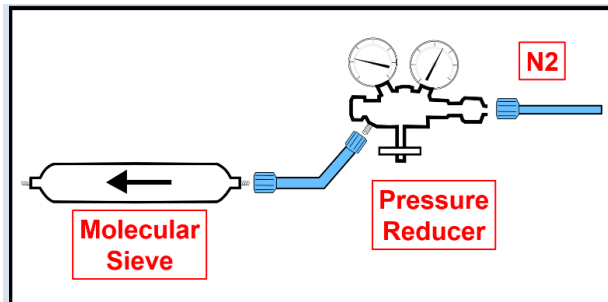

Connect nitrogen gas (Purity 5.0 or better) source to input of supplied molecular sieve using a PFA tube.



INFORMATION!

Recommended pressure of **Operation Gas** (Driftgas / Carriergas) is 5 **bar (500 kPa)**. 6 bar (600 kPa) must not be exceeded.

8

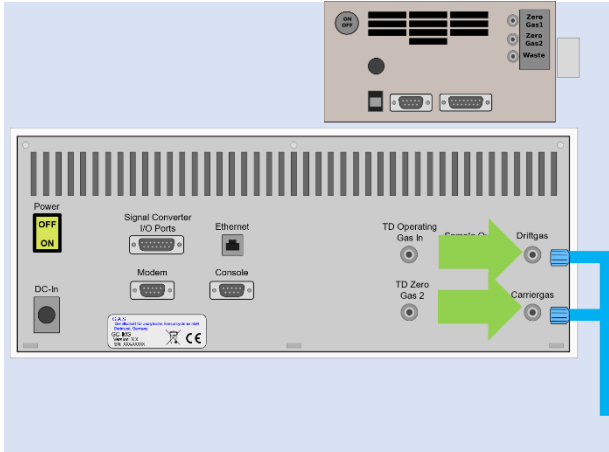

Connect the Driftgas-/Carriergas-Adapter to the Driftgas- and the Carriergas-Connector.

9

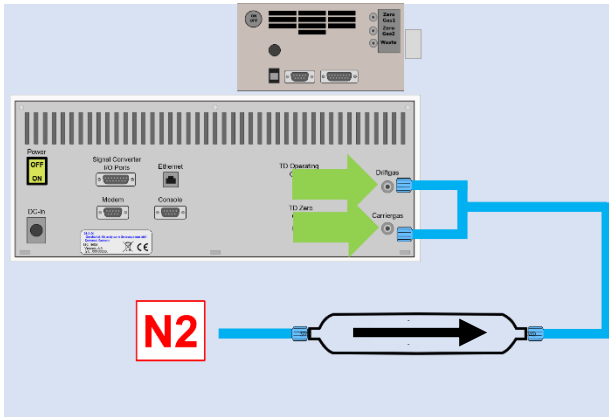

Connect molecular sieve outlet to **Driftgas-/Carriergas-Adapter** using a PFA tube.

10

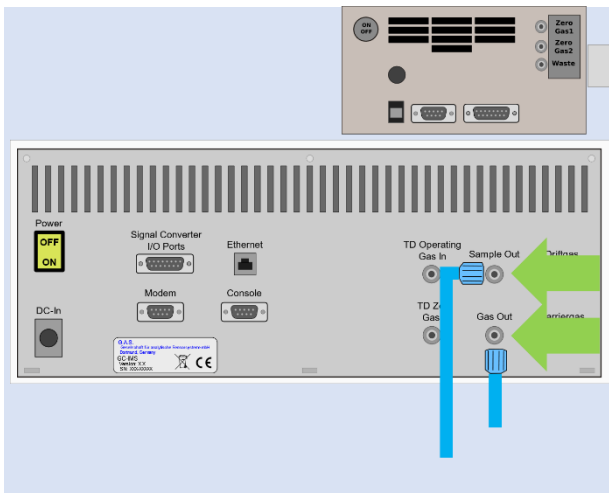

Separately connect sockets **Sample Out** and **Gas Out** to appropriate waste gas ventilation system.



INFORMATION!

To ensure correct measurements it is necessary to **connect the supplied exhaust tubes** (Gas out and Sample gas out).

The exhaust tubes (Gas out and Sample gas out) **must be led separately into the exhaust system and must not be connected.**

The exhaust system must **not generate any negative pressure.**

11

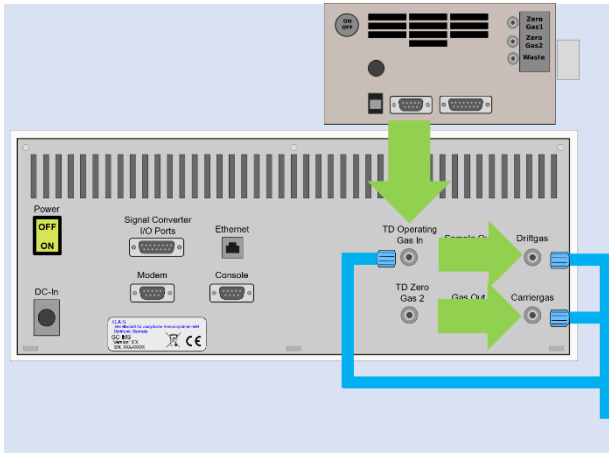

Connect TD operating gas in socket to **Driftgas- / Carriergas-Adapter** using a 3 mm Swagelok PFA tube.

12

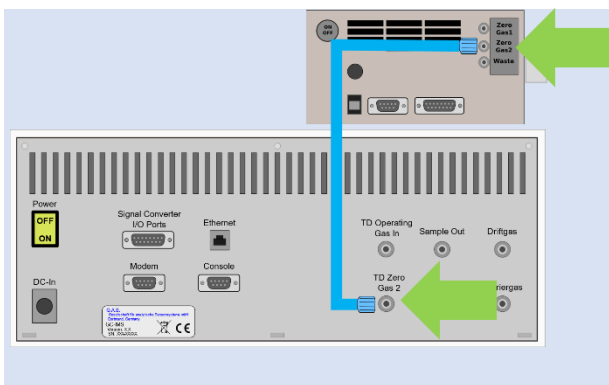

Also connect Outlet **ZeroGas 2** and **TDZero Gas 2** using a 3 mm Swagelok PFA tube.

For further information see: Airsense μ TD manual

13

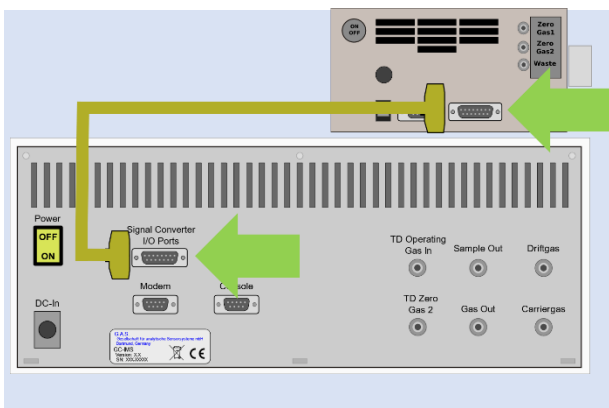

Connect BreathSpec **Signal Converter I/O-Port** to **μ TD Digital Port** with appropriate Connection-Cable.

14

Connect the μ TD with a computer via USB cable.

15

Connect the μ TD detector transfer line to sample in socket of BreathSpec.

16

Connect the μ TD sampling transfer line to μ TD.

17

Connect a sample gas source to sampling transferline with the delivered bypass adapter.

18

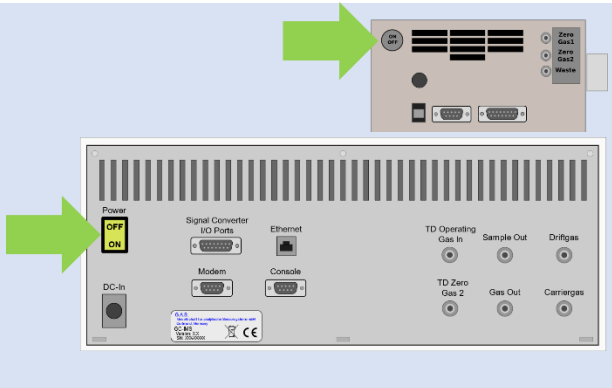

Switch on both devices.

19

Option

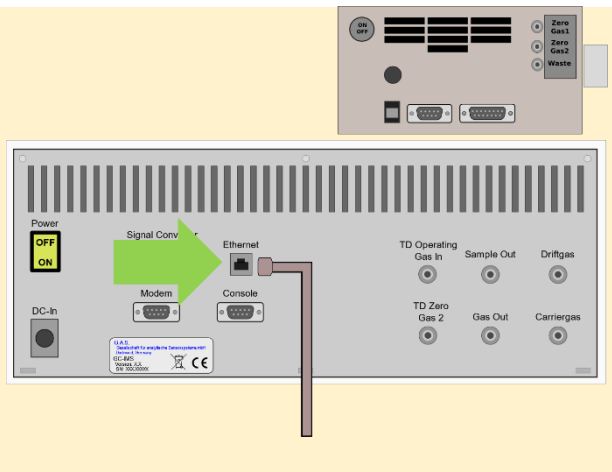

For file transfer via LAN:
Connect the **Ethernet** socket with an appropriate Ethernet cable to a LAN.

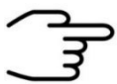

INFORMATION!

For detailed information about the installation and operation of the μ TD please refer the **[\$\mu\$ TD-GC-IMS Additional Information Quickstart](#)** and the **[Airsense \$\mu\$ TD Manual](#)**.

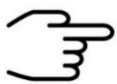

INFORMATION!

When the μ TD unit is connected to BreathSpec®, the current loop data output cannot be used.

6.3 Prepare the device for operation

Before using the device for the first time or after being disconnected from the nitrogen source for some time it must be cleaned to ensure proper operating conditions. In this case start the **cleaning mode**.

An appropriate cleaning period duration must be chosen depending on how long the device was switched off and on the extent of contamination. It is recommended to clean the device for at least **15 hours** before operating it for the first time. If the Spectrum is not clean repeat the process. A **reference spectrum** for the evaluation can be found in the supplied **Analytical Approval**.



INFORMATION!

After the cleaning process the device needs at least **2 hours** to cool down the internal components to their required temperatures.

The duration of the cool down process is depending on the temperature default settings.

1

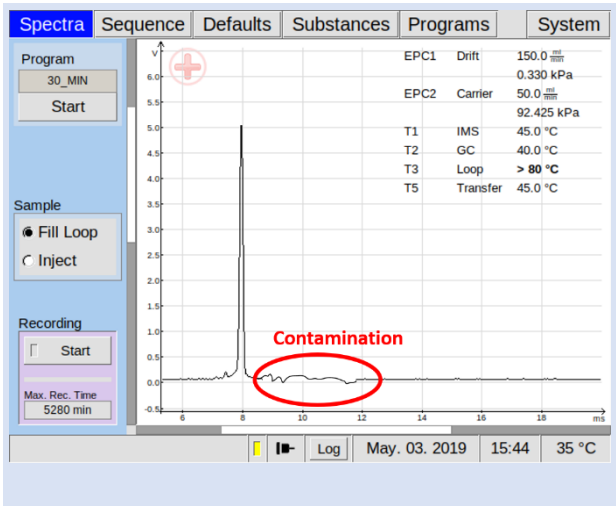

Inspect spectrum for contamination. Control the baseline. Start cleaning when contaminated. Contamination is indicated by peaks or the disappearing of the RIP.

2
Option

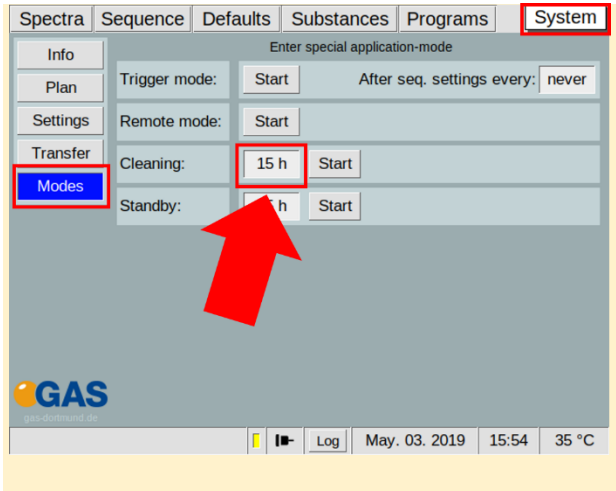

Select duration in hours:

System > **Modes** >
Cleaning Mode > **x h**

3
Option

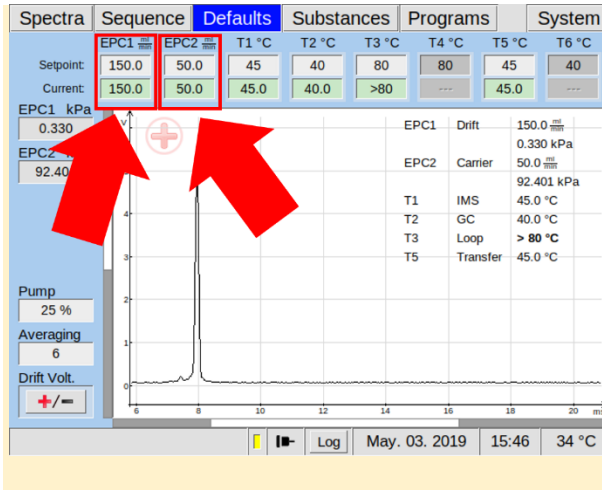

To speed up this process, increase flow rate of EPC1 and EPC2 to their maximum values (e.g 500/150 ml/min):

Defaults > **EPC1** > **EPC2**

4

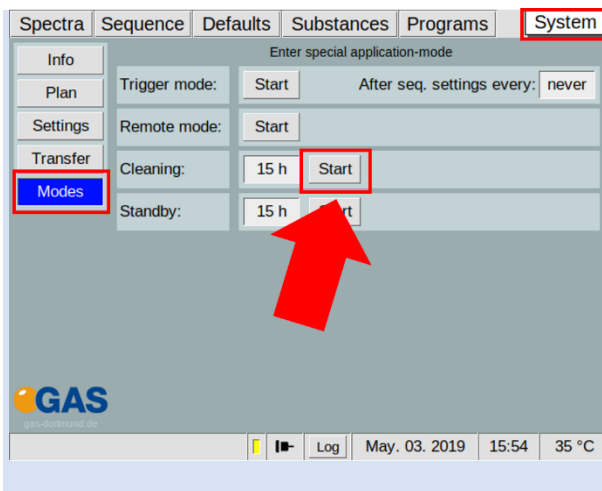

Start cleaning:

System > **Modes** >

Cleaning Mode > **Start**

5

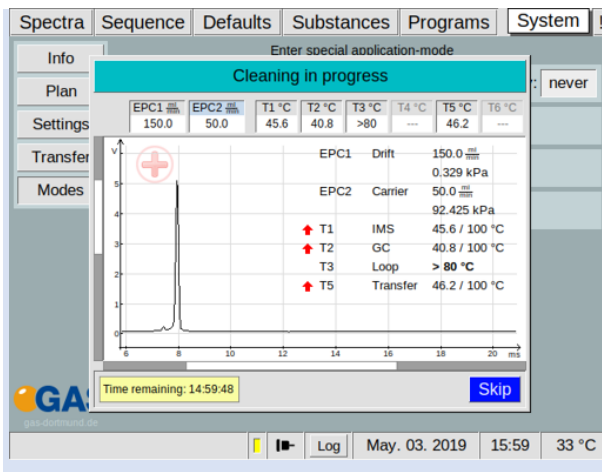

Wait until cleaning process is completed. The process can be stopped with **Skip**.

6

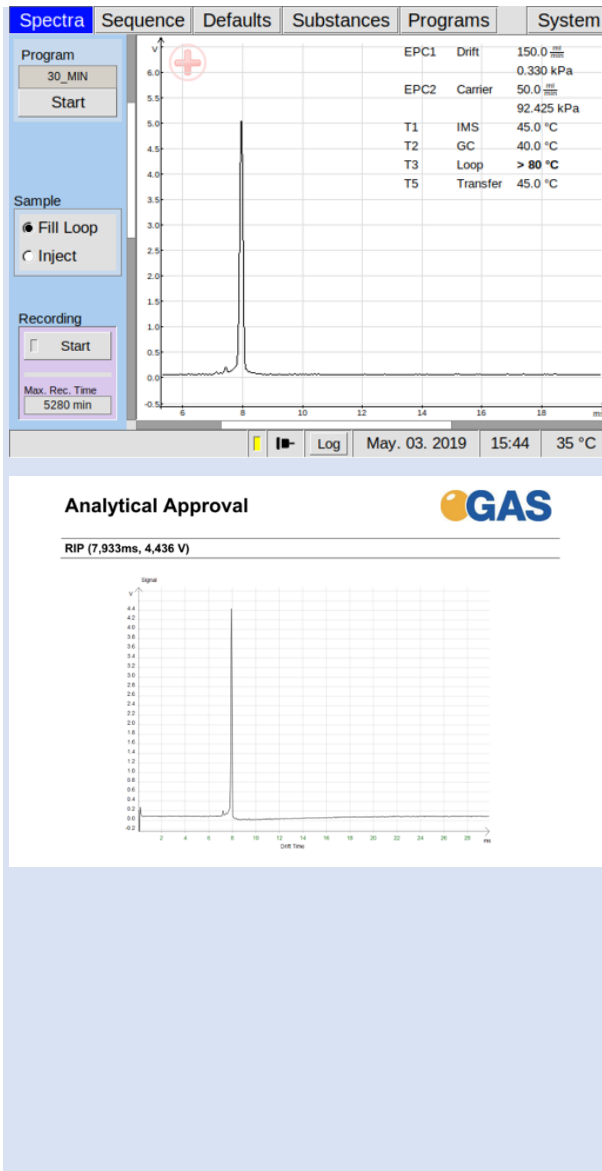

After all temperatures reached the default values inspect visually the current spectrum and compare it with the reference spectrum of the analytical approval. **The RIP should reach ~80% of the RIP height displayed in the delivered Analytical Approval of the device under same measurement conditions of G.A.S.** The assessment of the readiness to measure is additionally supported by the system.

If not check the gas quality and/or install additional purification cartridges and start the cleaning procedure again.

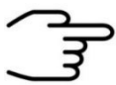

INFORMATION!

The device is delivered with an acceptance snapshot. This snapshot defines the system performance during device acceptance and is used to assess the readiness for measurement. Any deviations from this are displayed in the Error Information Window. **The default values can be adjusted by the customer.**

7 System Operation

7.1 Measurement Requirements

**INFORMATION!**

Only use the original accessories supplied with the device.

**INFORMATION!**

Make sure that the gas quality is 5.0 (99,999%) or better.

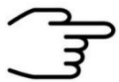
**INFORMATION!**

Only use stainless steel pressure reducer.

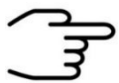
**INFORMATION!**

Make sure that the spectrum is clean a without contamination.

**WARNING!**

Do not introduce any liquids. This can destroy the device.

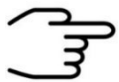
**INFORMATION!**

Make sure that that all temperature-, flow- and pressure values have reached their default value and are stabilized.

7.2 Measurement Program

The BreathSpec will **by default** be equipped with a general measurement program called **'BREATH'**. This program may need to be subject for method optimization **see [BreathSpec User Manual](#)**. Please be aware that editing the program may require changes in the timeline of sampling in order to sample the exhaled breath.

The following workflows describe the analysis of human breath exemplarily using the 'BREATH' program.

7.3 Workflow: Breath Sampling via Handheld Breath Sampler

7.3.1 Workflow: Installation of Disposable Reservoir Tube and Mouthpiece



INFORMATION!

In order to sample via the handheld breath sampler, the respective tube port has to be installed [see chapter 5.4](#).



DANGER

- Biohazard: wear appropriate gloves at all handling steps
- Take measures to prevent contamination from one subject/patient to other



WARNING

- Pinching possible

1



The image shows the parts necessary to set up the device for a breath analysis.

2



Insert new reservoir tube.

Check matching of Luer tip and reservoir's drilled hole.

3



Plug in the mouthpiece into narrow end of the reservoir tube. Screwing the mouthpiece may ease plugging in.

4



The image shows installed reservoir tube kit.

7.3.2 Workflow: Execute a breath measurement using the Handheld

1

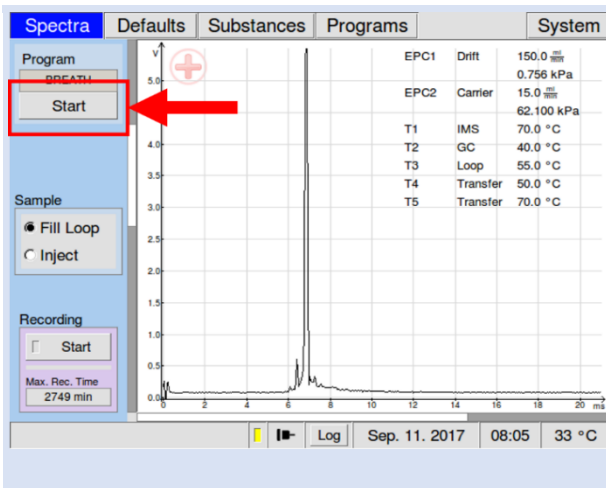

Select the Start button.

The dialog 'Start program' appears.

BreathSpec® – Quickstart Manual

2

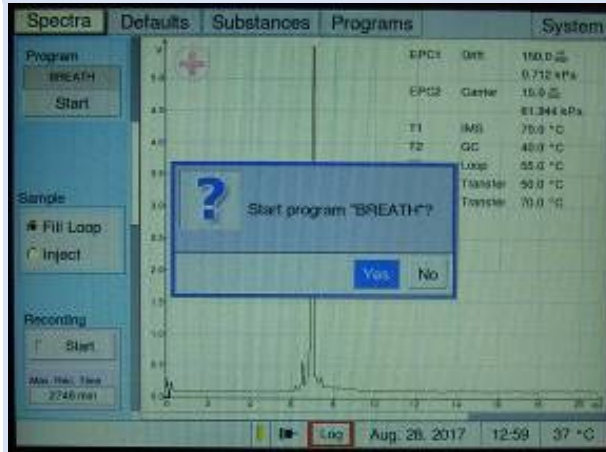

Select the <Yes>button with the pushable rotary knob (focus - background is blue), but do not start.

3



Ask the subject/patient to exhale smoothly into the mouthpiece mounted on the handheld.

[in case of a mistrial (cough etc.) the subject/patient can repeat exhalation]



{best practice is letting the subject/patient exhale into the handheld still attached to the device without touching it. If touched, the handheld can be wiped clean with an alcohol free tissue}

4

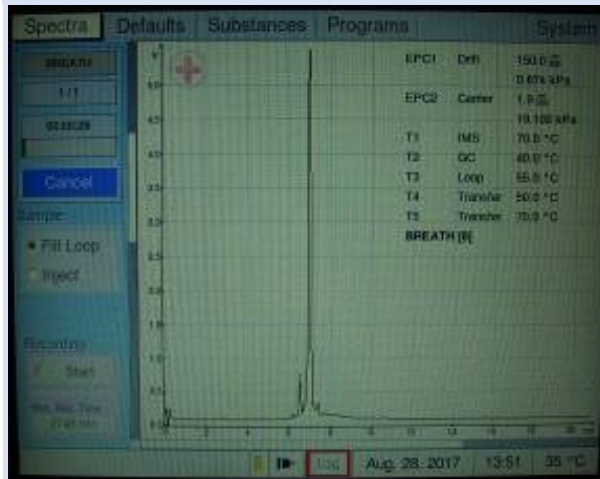

Upon ending of exhalation, the operator presses the pushable rotary knob to start the selected program.

[Arranging a sign with the patient to indicate ending of exhalation may be of benefit to match the right starting point]

> subject/patient can stop exhaling

> analysis is initiated (progress bar indicates runtime)

5



Pull out the used disposable reservoir tube.

The analysis will continue as defined in the program (approx. 10 min for the 'BREATH' program)



INFORMATION!

Dispose the syringe, reservoir tube and mouthpiece.

7.4 Workflow: Breath Sampling via Disposable Breath Sampler

7.4.1 Start a breath measurement using disposable breath sampler



INFORMATION!

To sample via the Luer-Lock-Adapter the respective tube port has to be installed [see chapter 5.5](#).



DANGER

- Biohazard: wear appropriate gloves at all handling steps
- Take measures to prevent contamination from one subject/patient to other



WARNING

- Pinching possible

1

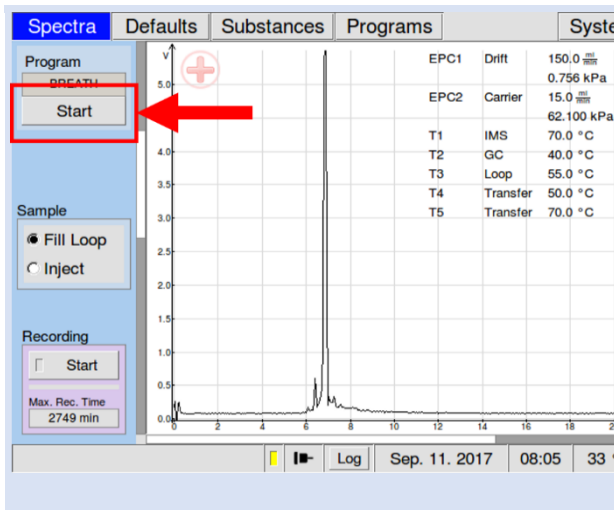

Select the Start button.

The **dialog** 'Start program' appears.

2

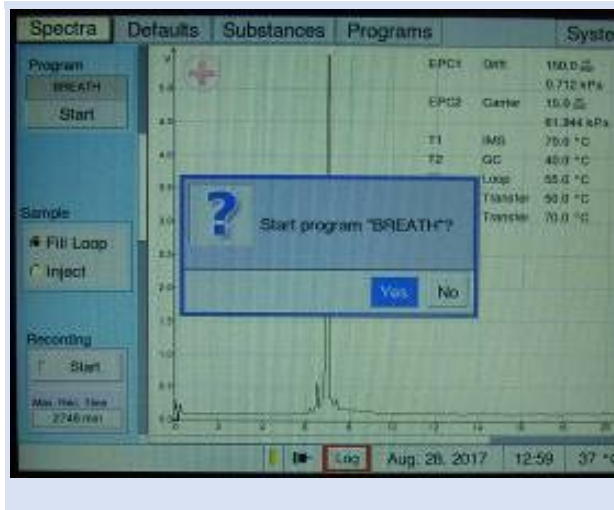

Select the **<Yes>** button with the pushable rotary knob with the pushable rotary knob (focus - background is blue), but do not start.

3



Plug in the mouthpiece into the narrow end of the reservoir tube. Screwing the mouthpiece may ease plugging in.

4



Connect the 5 ml Syringe with the reservoir tube. Screwing the mouthpiece may ease plugging in.

5



Ask the subject/patient to exhale smoothly into the mouthpiece mounted on the handheld.

During the exhalation sample breathing air into the syringe.

[in case of a mistrial (cough etc.) the subject/patient can repeat exhalation]

[Note that the breath sample may alter with time in the syringe]

6



Disconnect the syringe from the reservoir tube.

Insert the syringe into sample in connector with integrated Luer port.

Smoothly inject the breathing air into the sampling Luer port.

Towards the ending of injection press the pushable rotary knob to start the selected program.

7

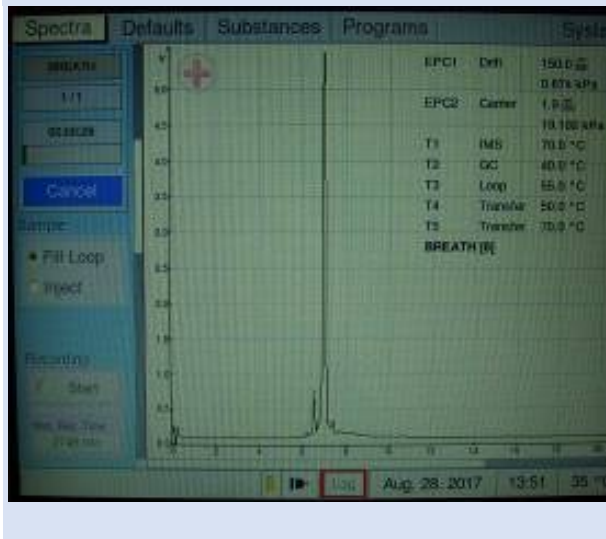

> analysis is initiated (progress bar indicates runtime)



INFORMATION!

Dispose the syringe, reservoir tube and mouthpiece.

7.5 Workflow: Exemplary Breath sampling with a sample bag

1

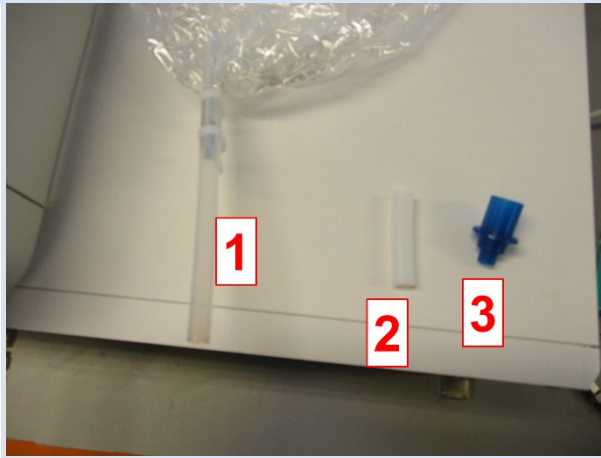

The components for breathing air sampling with the gas bag:

1: Sampling bag

2: Sampling bag adapter

3: Mouthpiece

2



Put all components together

3

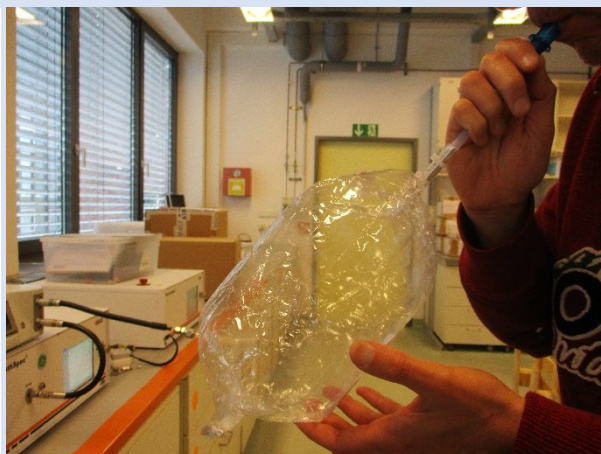

Fill the sample bag with breathing air.

4



Connect the sampling bag to μ TD sampling transferline.

5



Set BreathSpec to Triggemode and start the μ TD.

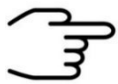

INFORMATION!

- For detailed Information refer to the [Airsense uTD Handbook](#) and the [\$\mu\$ TD GC-IMS Additional Information Quickstart](#)

7.6 Workflow: Measurement in ID Input Mode

1

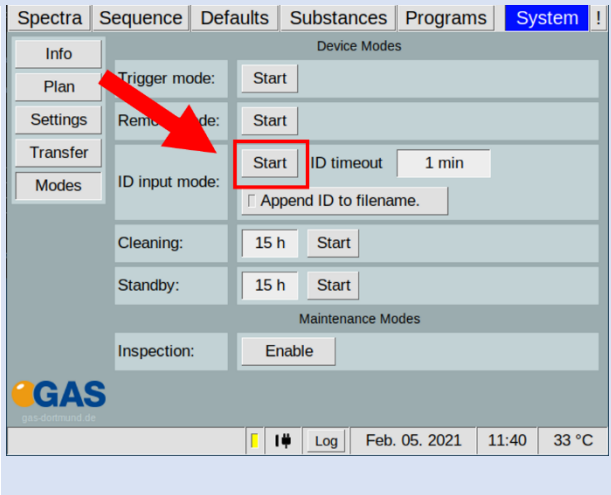

Select ID Input Mode:

System > **Modes** > **ID**

Input Mode > **Start**

2

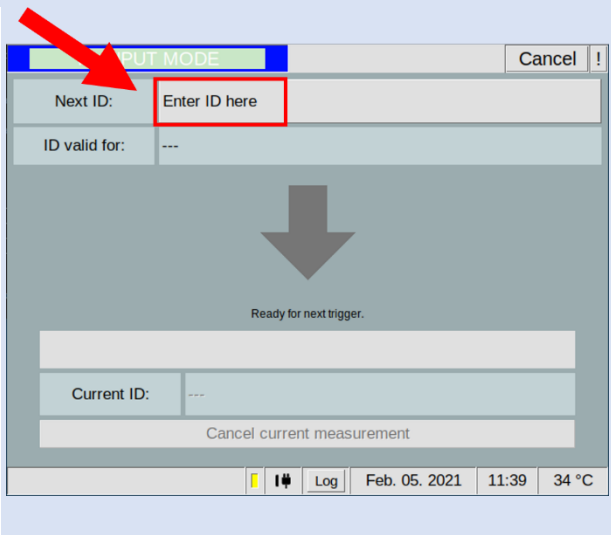

In ID Input Mode window select the ID field and enter an ID.



INFORMATION

The entry of an ID is mandatory.





3



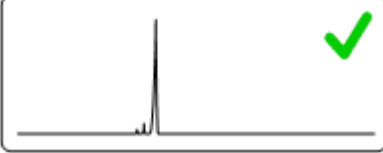

Start measurement with μ TD-start button.

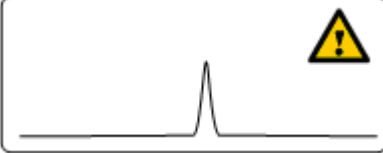
8 Appendix

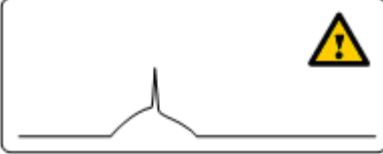
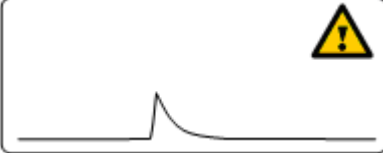
8.1.1 IMS-Spectrum Examples

Schematic of IMS spectrum	Spectrum description	reasons / suggestions
	Clean spectrum	Perfect
	Clean spectrum, up to two extra signals left hand side of the RIP	Perfect
	RIP shifted to lower drift times	<ul style="list-style-type: none"> - elevated temperature - reduced pressure
	RIP shifted to higher drift times	<ul style="list-style-type: none"> - low temperatures - elevated pressure
	RIP deformed	<ul style="list-style-type: none"> - gas quality out of specifications - device needs to be flushed for some time - flows not in range
	RIP base deformed yet visible	<ul style="list-style-type: none"> - gas quality out of specifications - device needs to be flushed for some time - flows not in range
	RIP deformed towards tailing	<ul style="list-style-type: none"> - gas quality out of specifications - device needs to be flushed for some time - flows not in range

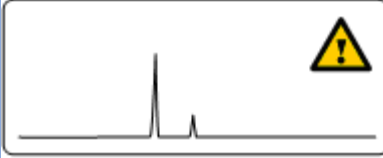
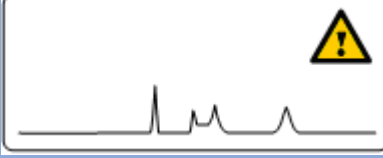
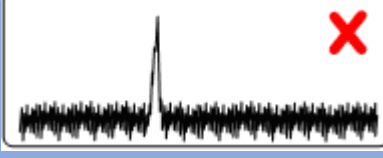
BreathSpec® – Quickstart Manual

	<p>Minor impurities</p>	<ul style="list-style-type: none"> - gas quality out of specifications - device is polluted > run system cleaning
	<p>Major impurities</p>	<ul style="list-style-type: none"> - gas quality out of specifications - device is polluted > run system cleaning
	<p>Elevated noise</p>	<p>Contact G.A.S. support</p>
	<p>No signal</p>	<p>Contact G.A.S. support</p>

8.2 Corresponding G.A.S. Documents and Tutorials



INFORMATION!

- BreathSpec User Manual
- CGFU User Manual (optional)
- Airsense uTD Handbook (optional)
- μ TD GC-IMS Additional Information Quickstart (optional)
- Sequence Designer Manual
- IMS Control TFTP-Server Manual
- Tutorials Sequence Designer
- Tutorials VOCal
- Manuals VOCal